

Instruções Peça 1

1 Recorte o contorno da figura.

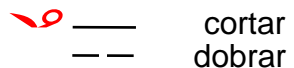

2 Dobrar com um lápis, conforme a figura 1, nos lugares indicados.



figura 1

3 Seguir a colagem conforme indicado.



Dobrar com um lápis

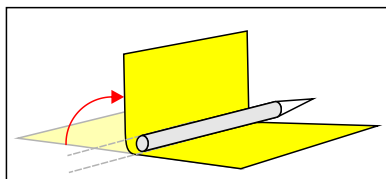
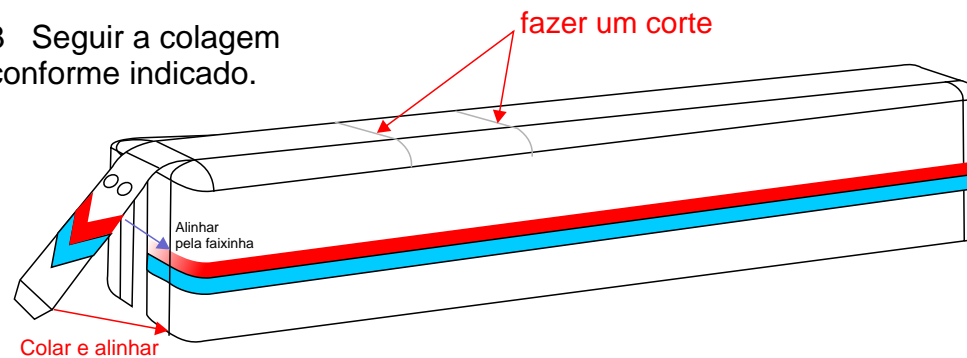

Dobrar com um lápis



Dobrar com um lápis

Dobrar com um lápis

Dobrar com um lápis



Dobrar com um lápis

Dobrar com um lápis

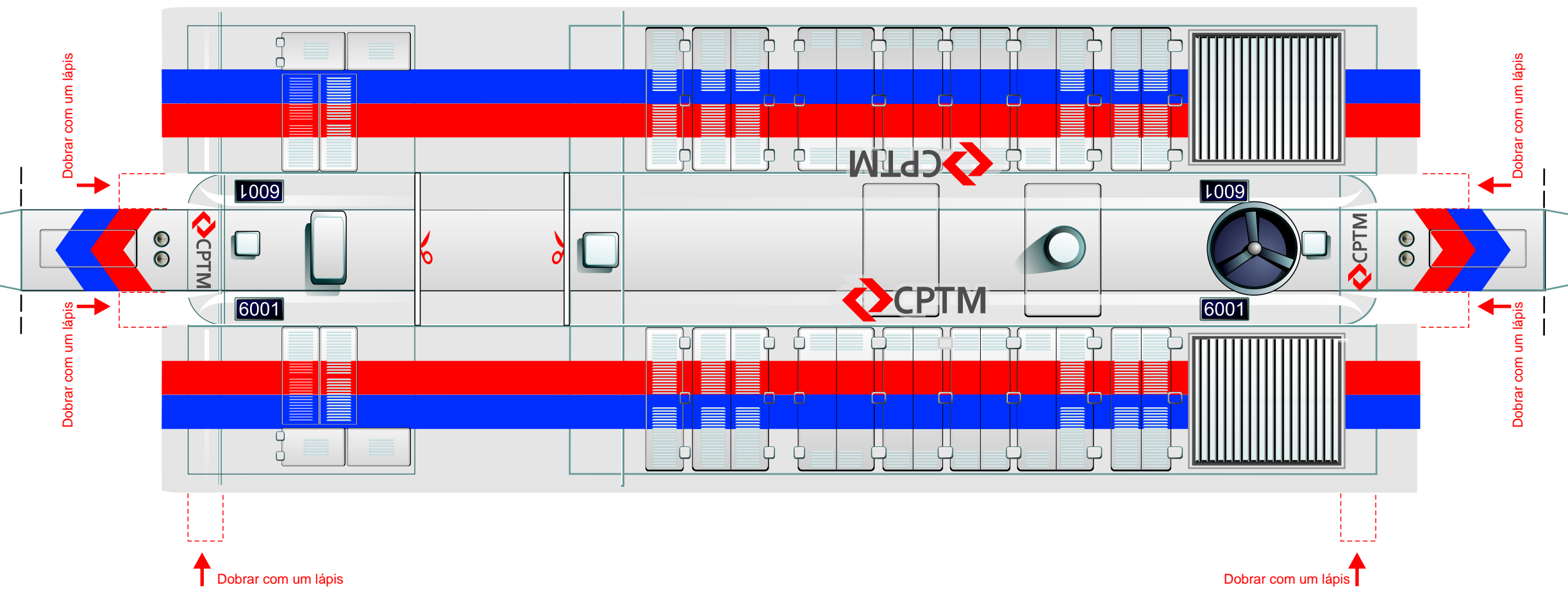
Dobrar com um lápis



Instruções Peça 3

- 1 Recorte o contorno da figura.
 - 2 Dobre nos lugares indicados
-  — cortar
 — dobrar

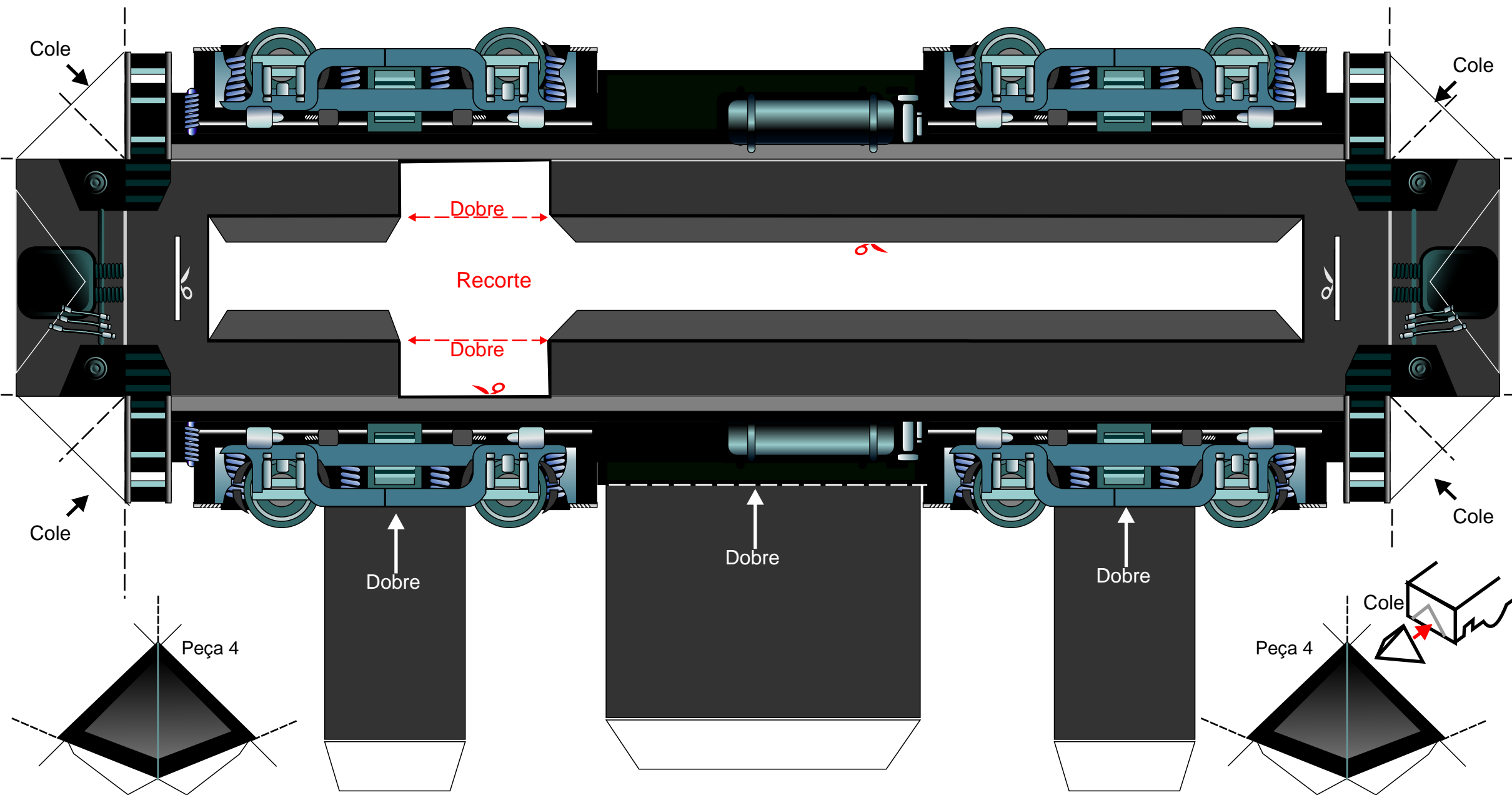

Instruções Peça 2

- 1 Recorte o contorno da figura.
- 2 Dobre nos lugares indicados
- 3 Monte conforme a figura 2



figura 2

- 4 Dobre e Cole as bandeirinhas em um palitinho. (conforme figura 3)
Você pode pintar os palitinhos na cor preta.



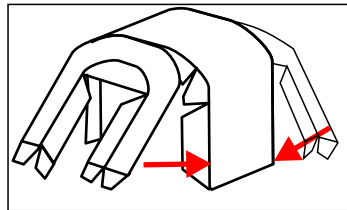
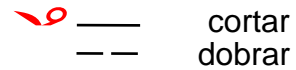

figura 3

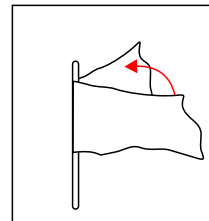
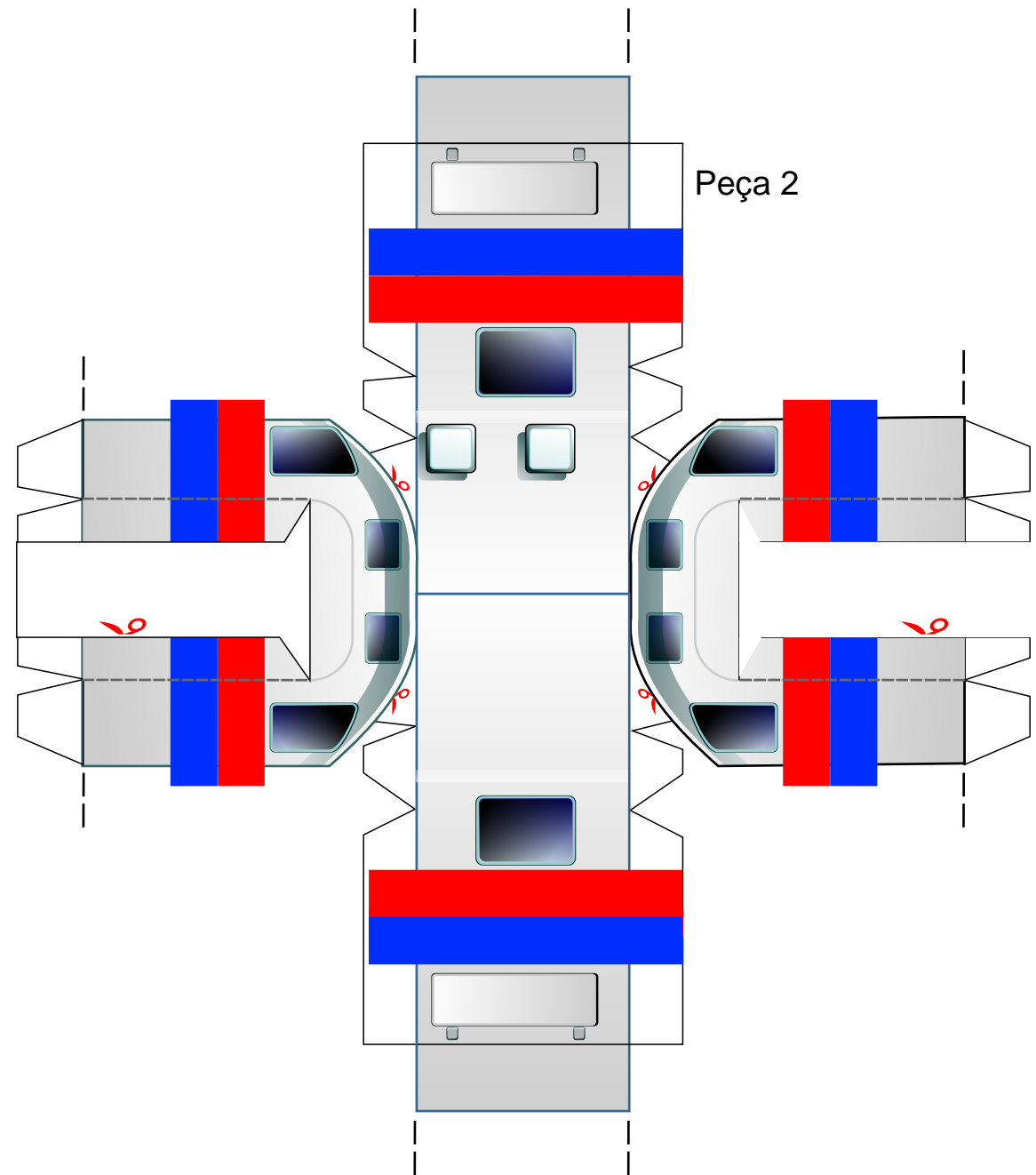
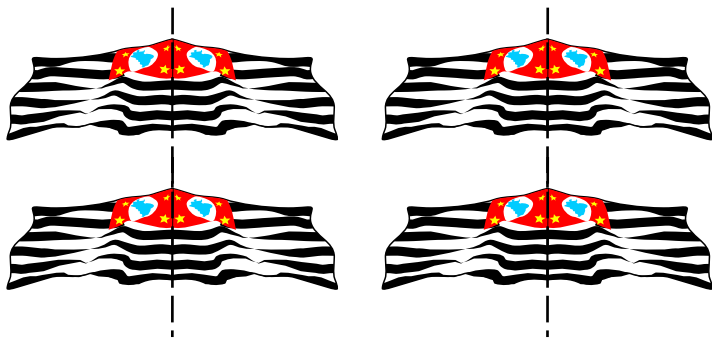

Instruções Vagão Peça B

1 Recorte o contorno da figura.

 — cortar

Vagão Peça B

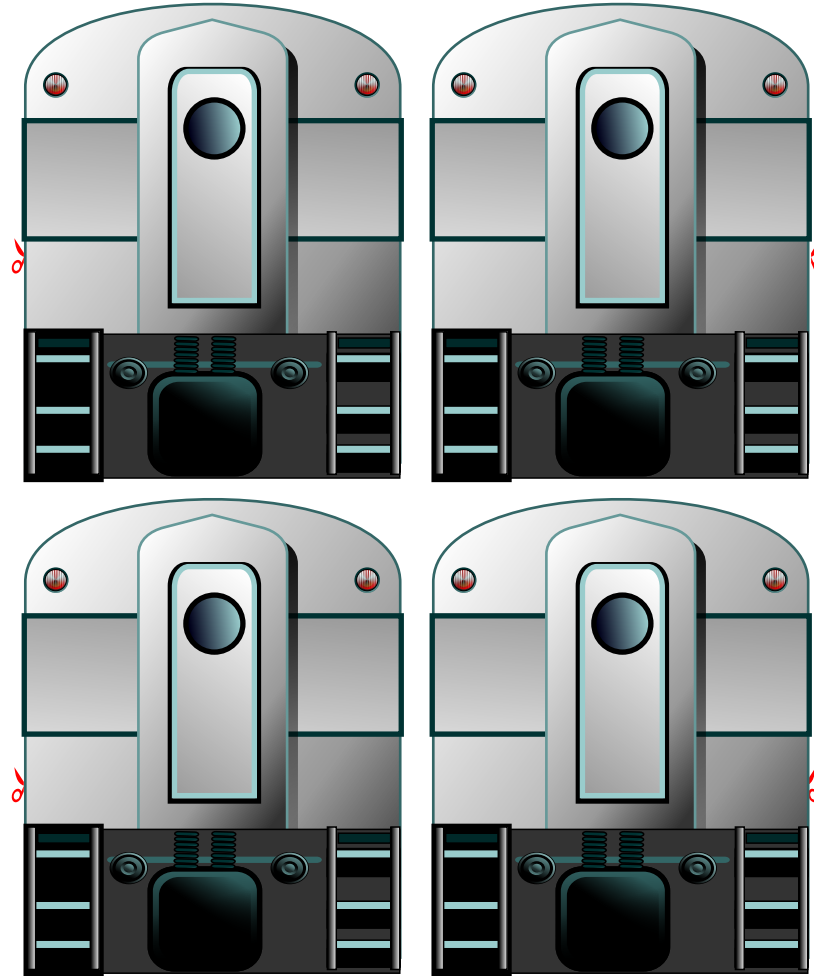

Dobre ↓

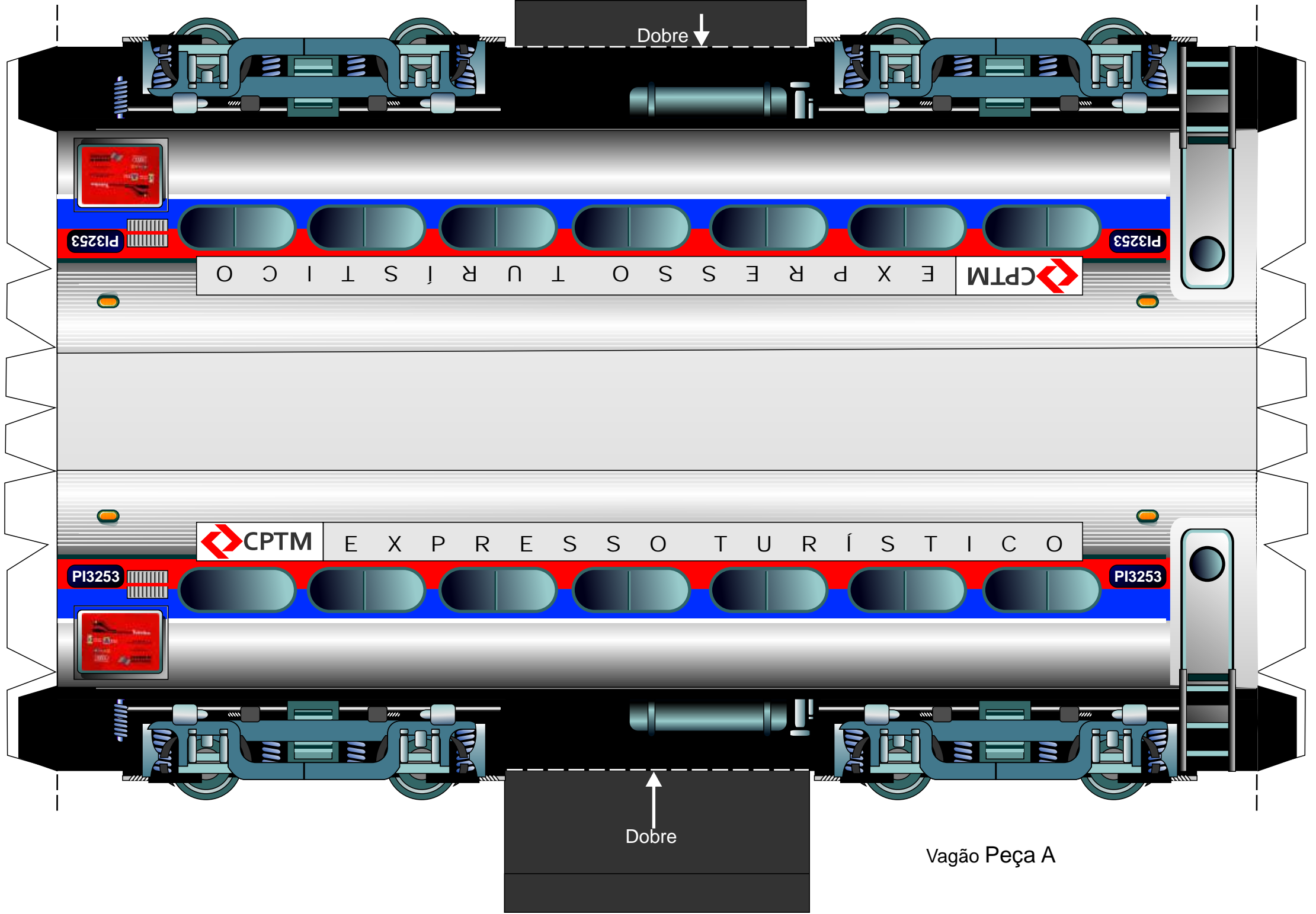

Vagão Peça A

Dobre ↓

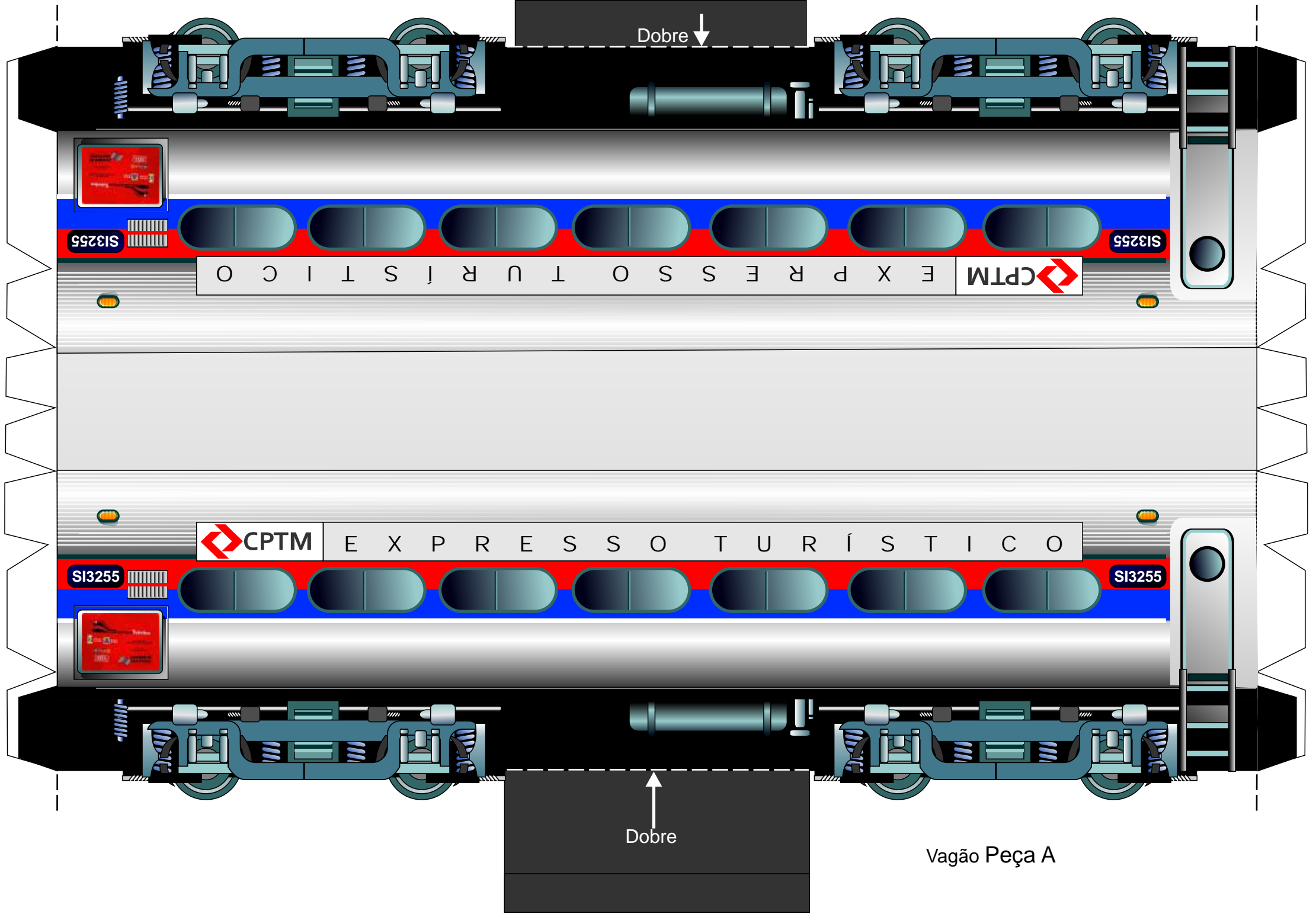

CPTM EXPRESSO TURÍSTICO

SI3255

SI3255

CPTM EXPRESSO TURÍSTICO

SI3255

SI3255

Dobre ↑

Vagão Peça A

Instruções

Montagem da locomotiva

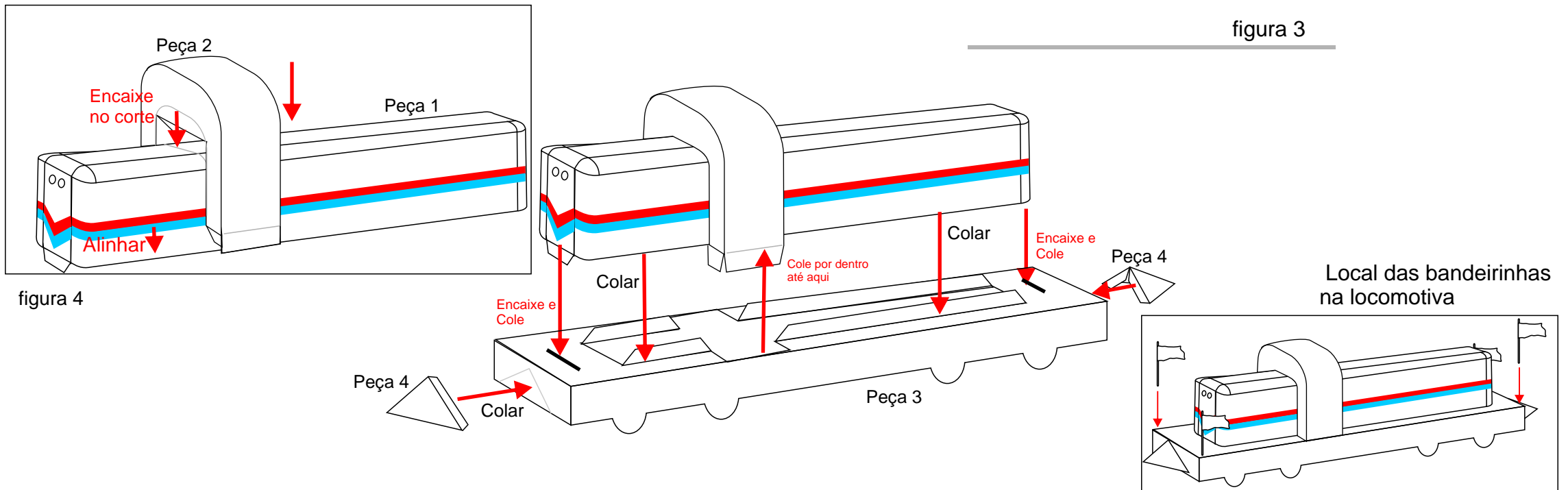

Montagem do vagão

